

If you have any missing part or question please email to info@transdecointl.com or call 909-606-3833
 Mon - Fri 9 AM to 5 PM PST. Please have your product model number available.

STEP 1

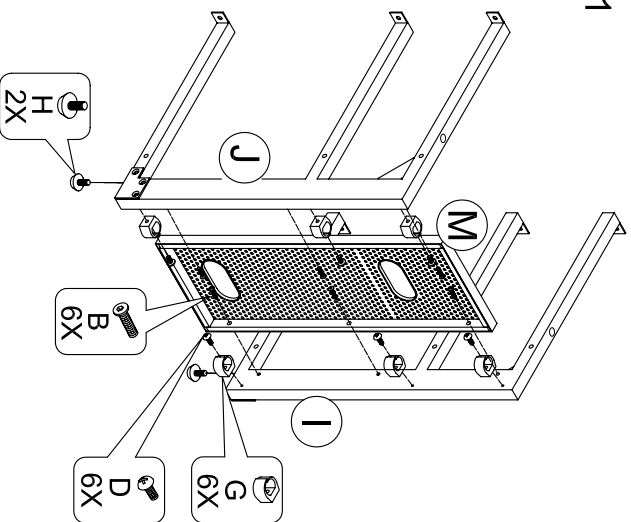

STEP 2

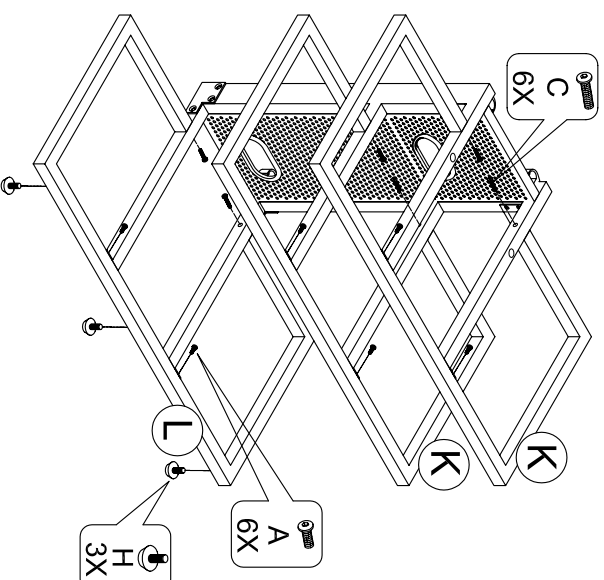



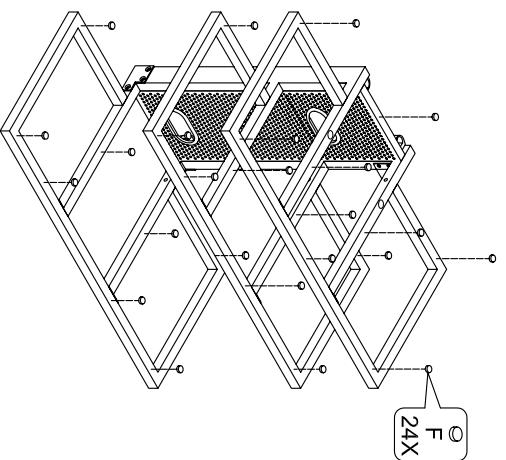



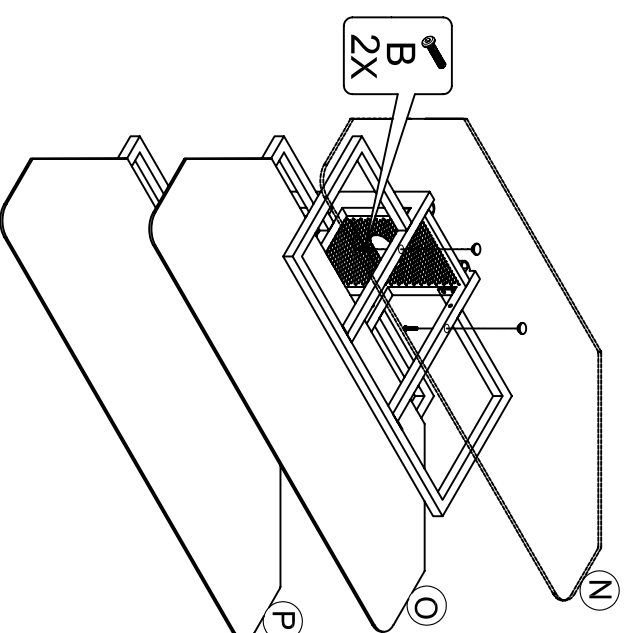









STEP 3



STEP 4



NO.	DESCRIPTION	QTY
A	 M6x12mm	6
B	 M6x25mm	8
C	 M6x38mm	6
D	 M4x15mm	6
E	 L M4	1
F	 Ø12x3.5mm	24
G		6
H	 M6	5
I		1
J		1
K		2
L		1
M		1
N	 T=8mm	1
O	 T=6mm	1
P	 T=6mm	1