



TD30DB

If you have any missing parts or questions please email
 Mon - Fri 9 AM to 5 PM pacific time. Please have your product model number available.

STEP 1

- * Install the spiked feet (Part C) and test the balance for the base. Adjust the level if necessary.
- * Tighten all the screws to lock the position.

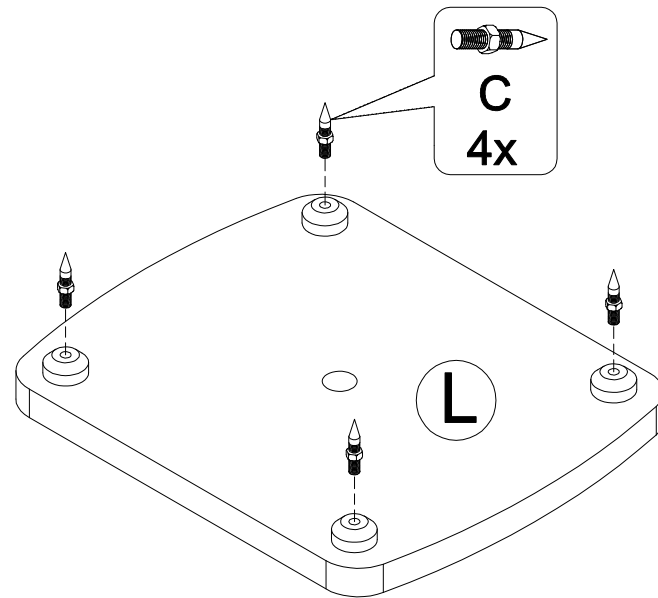

STEP 2 (optional)



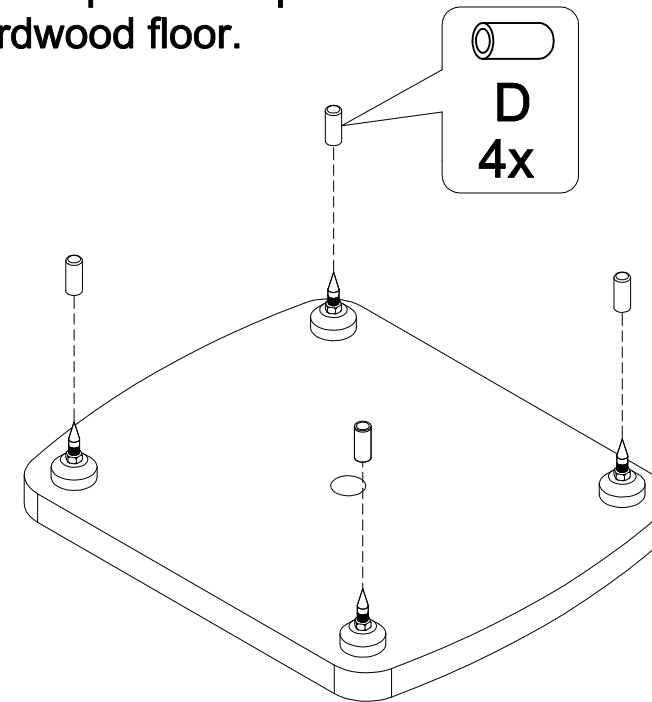





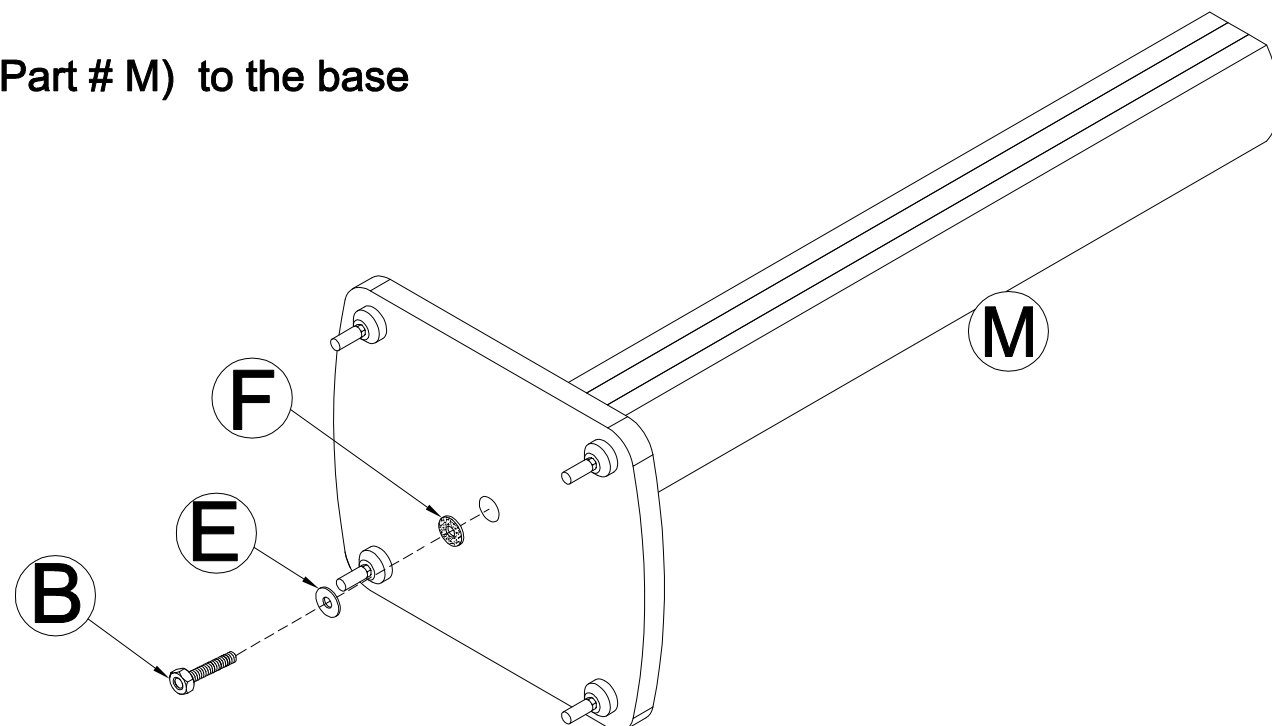



- * Install the plastic cap for the spiked feet if it's on hardwood floor.

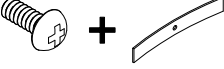

STEP 3

- * Attach the pole (Part # M) to the base as shown.

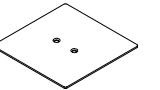
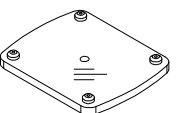
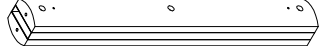

NO.	DESCRIPTION	Q'TY
A	M6 	2 x 2
B	M10 	1 x 2
C	M6 	4 x 2
D		4 x 2
E		1 x 2
F		1 x 2
G	 + 	2 x 2 set
H		4 x 2
I	M10  M17 	1+1
J	M4 	1
K		1 x 2
L		1 x 2
M		1 x 2

STEP 4

* Install the top plate (Part # k).

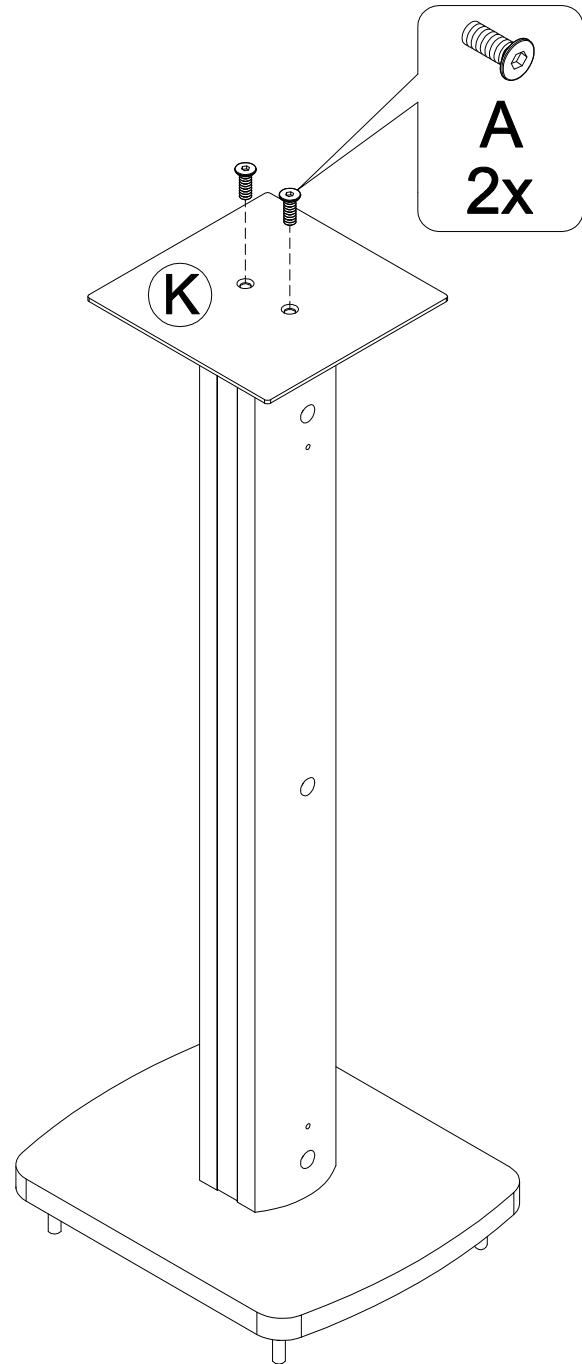

STEP 5

* Attach the velcro (Part G) for the wires.

* Attach the soft pad (Part H) on the top plate.

