

STEP 1

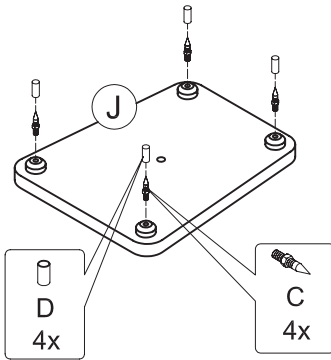

STEP 2

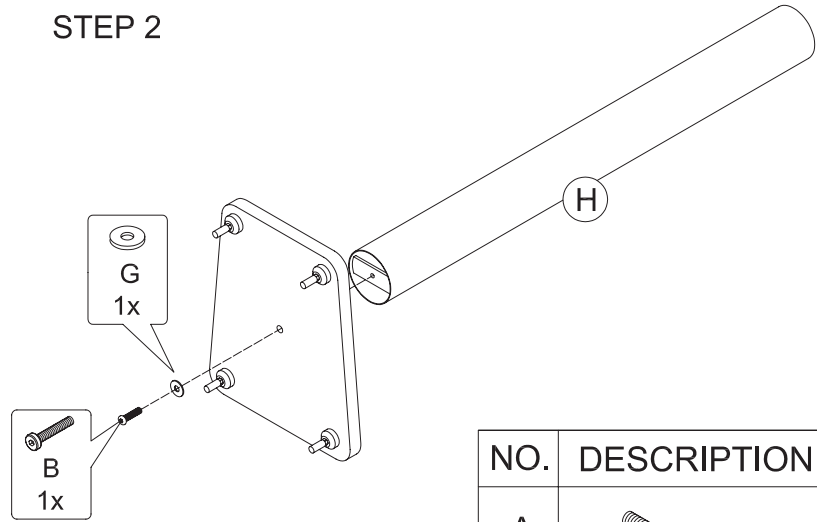



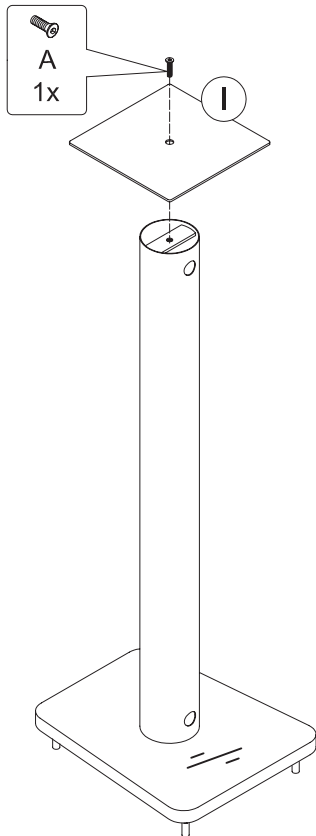

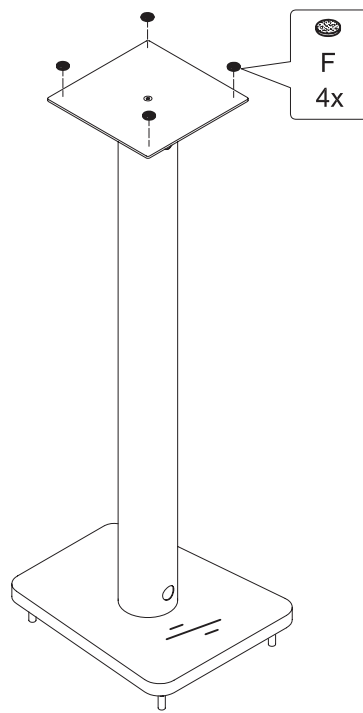

STEP 3



STEP 4

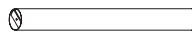
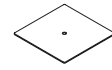
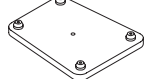

NO.	DESCRIPTION	Q'TY
A	 M8x25mm	1 x2
B	 M8x40mm	1 x2
C	 M6	4 x2
D		4 x2
E	 M5	1
F	 Ø15mm	4 x2
G	 Ø32xØ8x2.0mm	1 x2
H		1 x2
I		1 x2
J		1 x2