

TD210B

If you have any missing part or question please email to info@transdecointl.com or call 909-606-3833
 Mon - Fri 9 AM to 5 PM PST. Please have your product model number available.

STEP 1

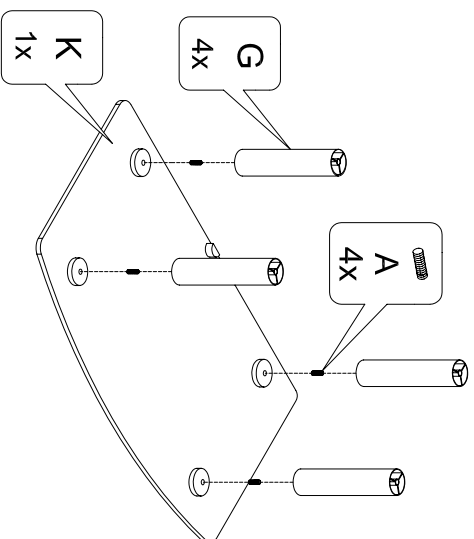

STEP 2

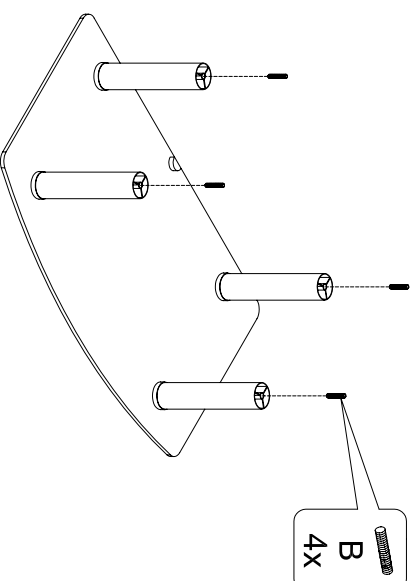



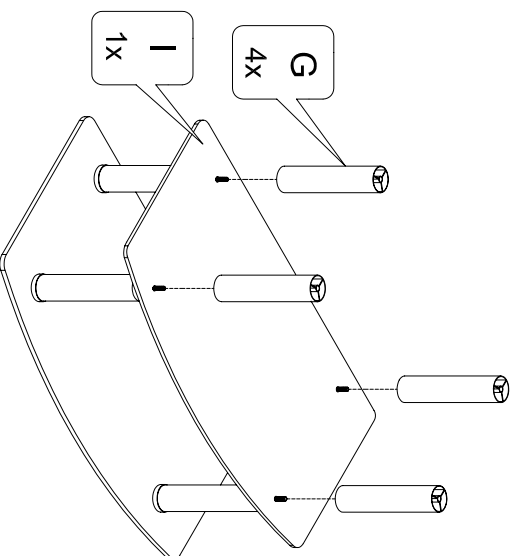



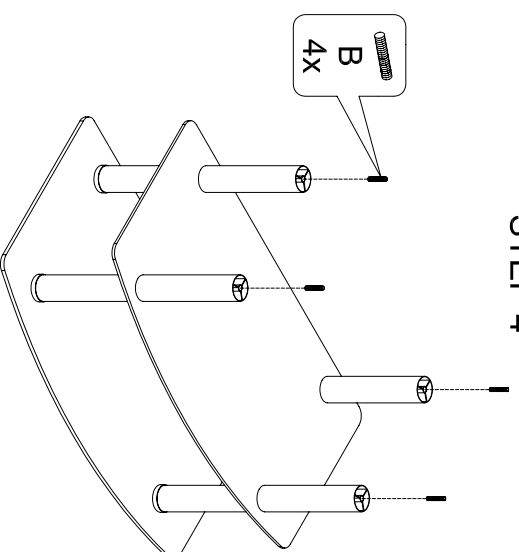

STEP 3



STEP 4

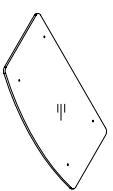
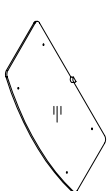
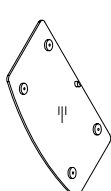

NO.	DESCRIPTION	QTY
A	M8x20mm 	4
B	M8x40mm 	8
C	M4x6mm 	2
D	 + 	4 set
E		4
F		1
G		12
H		1
I		2
J		1
K		1



TransDeco

TD210B

If you have any missing part or question please email to info@transdecointl.com or call 909-606-3833
Mon - Fri 9 AM to 5 PM PST. Please have your product model number available.

